





Cruzber S.A., ES-A14018311
P.I. Las Salinas II, E-14960 Rute
www.cruzber.com





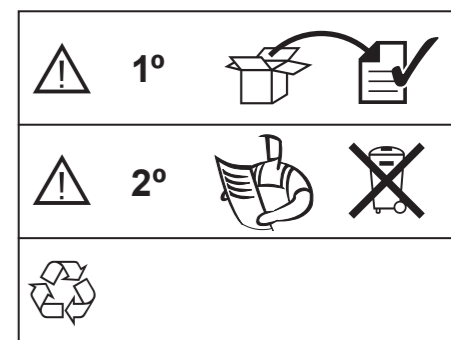

Código Code Code Kode	935-540		
	Lv 7 2015 - r 1		
Modelo Model Modèle Modell			
Lote Lot Lot Lot	01 -15	Peso Weight Poids Gewicht	1,20 kg
  			
Kit tipo Kit type Kit type Kit Typ	E		
Código Homologación ECE R26.03 R 26.03 ECE Type Approval Number	E9-26R-03.3015		

- (E) **Instrucción de montaje**
¡Leer primero!
- (GB) **Assembly instructions**
Read first!
- (F) **Instruction de montage**
Lire en premier!
- (D) **Montageanleitung**
Zuerst lesen!
- (PT) **Instruções de montagem**
Ler primeiro!
- (PL) **Instrukcja montażu**
Najpierw przeczytaj!
- (CZ) **Montážní návod**
Čtěte pozorně!
- (HU) **Szerelési Utasítás**
Először olvasd el!
- (RO) **Instructiuni de montaj**
Intai cititi!
- (HR) **Detaljne upute**
Prvo pročitati!
- (GR) **Διαβάστε προσεκτικά τις**
Οδηγίες Συναρμολόγησης!
- (TR) **Öncelikli montaj:**
Talimatlarını okuyunuz!
- (RU) **Инструкции по монтажу**
Сначала прочитайте!
- (IT) **Istruzioni di montaggio**
Leggere per primo!
- (NL) **Montagehandleiding**
Eerst lezen!
- (SLO) **Navodila za sestavljanje**
Preberite!

- Kit fijación
- Fixation Kit
- Kit fixation
- Stützfuß-Kit
- Kit fixação
- Element mocujący
- Fixační kit
- Rögzítő készlet
- Kit de fixare
- Kit za montažu
- Κιβώτιο (Kit) Επισκευής
- Montaj kiti
- Крепежный комплект
- Kit di fissaggio
- Bevestigingsset
- Kit za pričvrstitev

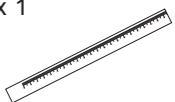

- (E) **Contenido embalaje:** ¡Verificar!
- (GB) **Package content:** Check!
- (F) **Contenu d'emballage:** Vérifier!
- (D) **Packungsinhalt:** Überprüfen!
- (PT) **Contéudo embalagem:** Verificar!
- (PL) **Zawartość opakowania:** sprawdź!
- (CZ) **Obsah balení:** Zkontrolujte!
- (HU) **Csomag tartalma:** Ellenőrizd!
- (RO) **Pachetul contine:** Verificati!
- (HR) **Sadržaj paketa:** Provjeri!
- (GR) **Ελέγξτε το περιεχόμενο:** του πακέτου!
- (TR) **Paket içeriğini:** Control ediniz!
- (RU) **Содержание упаковки:** Проверьте!
- (IT) **Contenuto della confezione:** Controllare!
- (NL) **Pakket inhoud:** Controleer!
- (SLO) **Vsebina paketa:** Preverite!

x 1 	x 1 	x 1  (018-041)	x 1  (810-052)
x 4  1x (704-2315) 1x (704-2317) 1x (704-2319) 1x (704-2321)	x 4  1x (704-2314) 1x (704-2316) 1x (704-2318) 1x (704-2320)	x 4  (012-080)	x 1  (001-820)



Importante!
Important!
Important!
Wichtig!

- E** ¡Este Kit de fijación tiene que usarse con sistemas portacargas Cruz!
- GB** This fixation Kit must be used with Cruz roof rack systems!
- F** Cet Kit de fixation devra être utilisé avec les systèmes porte-charge Cruz!
- D** Dieser Stützfuß-Kit muß mit Cruz Dachträgersystemen benutzt werden!
- PT** Este Kit de fixação deve ser utilizado com os sistemas porta cargas Cruz!
- PL** Niniejszy element mocujący musi być używany z systemami bagażników dachowych firmy Cruz!
- CZ** Tento fixační kit musí být používán s nosným systémem Cruz!
- HU** Ez a rögzítő készlet csak a Cruz rendszerekkel használható!
- RO** Acest Kit de fixare, trebuie utilizat cu sisteme Cruz!
- HR** Kit za montažu mora biti korišten uz Cruz sistem krovnog nosača!
- GR** Το αξεσουάρ αυτό θα πρέπει να χρησιμοποιείται αποκλειστικά στα συστήματα μπαρών της Cruz!
- TR** Bu aksesuar mutlaka Cruz taşıma sistemleriyle kullanılmalıdır!
- RU** Крепежный комплект должен быть использован с багажной системой на крышу марки Cruz!
- IT** Questo kit di fissaggio deve essere usato con i portapacchi CRUZ
- NL** Deze bevestigingsset moet worden gebruikt in combinatie met Cruz dakdrager systeem!
- SLO** Kit za pričvrstitev naj se uporablja le z izdelki iz asortimana strešnih košar CRUZ!

