





Cruzber S.A., ES-A14018311  
P.I. Las Salinas II, E-14960 Rute  
www.cruzber.com





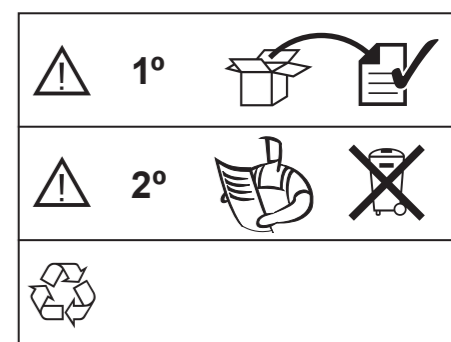

Código Code Code Kode	<b>935-542</b>
Lv 7 2016 - r 1	
Modelo Model Modèle Modell	
Lote Lot Lot Lot	01 -15
Peso Weight Poids Gewicht	0,96 kg
  	
Kit tipo Kit type Kit type Kit Typ	E
Código Homologación ECE R26.03 R 26.03 ECE Type Approval Number	
E9-26R-03.3015	

- (E) **Instrucción de montaje**  
¡Leer primero!
- (GB) **Assembly instructions**  
Read first!
- (F) **Instruction de montage**  
Lire en premier!
- (D) **Montageanleitung**  
Zuerst lesen!
- (PT) **Instruções de montagem**  
Ler primeiro!
- (PL) **Instrukcja montażu**  
Najpierw przeczytaj!
- (CZ) **Montážní návod**  
Čtěte pozorně!
- (HU) **Szerelési Utasítás**  
Először olvasd el!
- (RO) **Instructiuni de montaj**  
Intai cititi!
- (HR) **Detaljne upute**  
Prvo pročitati!
- (GR) **Διαβάστε προσεκτικά τις**  
Οδηγίες Συναρμολόγησης!
- (TR) **Öncelikle montaj:**  
Talimatlarını okuyunuz!
- (RU) **Инструкции по монтажу**  
Сначала прочитайте!
- (IT) **Istruzioni di montaggio**  
Leggere per primo!
- (NL) **Montagehandleiding**  
Eerst lezen!
- (SLO) **Navodila za sestavljanje**  
Preberite!

- Kit fijación
- Fixation Kit
- Kit fixation
- Stützfuß-Kit
- Kit fixação
- Element mocujący
- Fixační kit
- Rögzítő készlet
- Kit de fixare
- Kit za montažu
- Κιβώτιο (Kit) Επισκευής
- Montaj kiti
- Крепежный комплект
- Kit di fissaggio
- Bevestigingsset
- Kit za pričvrstitev

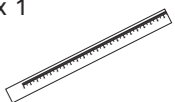

- (E) **Contenido embalaje:** ¡Verificar!
- (GB) **Package content:** Check!
- (F) **Contenu d'emballage:** Vérifier!
- (D) **Packungsinhalt:** Überprüfen!
- (PT) **Contéudo embalagem:** Verificar!
- (PL) **Zawartość opakowania:** sprawdzić!
- (CZ) **Obsah balení:** Zkontrolujte!
- (HU) **Csomag tartalma:** Ellenőrizd!
- (RO) **Pachetul contine:** Verificati!
- (HR) **Sadržaj paketa:** Provjeri!
- (GR) **Ελέγξτε το περιεχόμενο:** του πακέτου!
- (TR) **Paket içeriğini:** Control ediniz!
- (RU) **Содержание упаковки:** Проверьте!
- (IT) **Contenuto della confezione:** Controllare!
- (NL) **Pakket inhoud:** Controleer!
- (SLO) **Vsebina paketa:** Preverite!

x 1 	x 1 	x 1  (018-041)	x 1  (810-052)
x 4  1x (704-2330) 1x (704-2332) 1x (704-2334) 1x (704-2336)	x 4  1x (704-2329) 1x (704-2331) 1x (704-2333) 1x (704-2335)	x 4  (012-050)	x 1  (001-820)



**Importante!**  
**Important!**  
**Wichtig!**

- E** ¡Este Kit de fijación tiene que usarse con sistemas portacargas Cruz!
- GB** This fixation Kit must be used with Cruz roof rack systems!
- F** Cet Kit de fixation devra être utilisé avec les systèmes porte-charge Cruz!
- D** Dieser Stützfuß-Kit muß mit Cruz Dachträgersystemen benutzt werden!
- PT** Este Kit de fixação deve ser utilizado com os sistemas porta cargas Cruz!
- PL** Niniejszy element mocujący musi być używany z systemami bagażników dachowych firmy Cruz!
- CZ** Tento fixační kit musí být používán s nosným systémem Cruz!
- HU** Ez a rögzítő készlet csak a Cruz rendszerekkel használható!
- RO** Acest Kit de fixare, trebuie utilizat cu sisteme Cruz!
- HR** Kit za montažu mora biti korišten uz Cruz sistem krovnog nosača!
- GR** Το αξεσουάρ αυτό θα πρέπει να χρησιμοποιείται αποκλειστικά στα συστήματα μπαρών της Cruz!
- TR** Bu aksesuar mutlaka Cruz taşıma sistemleriyle kullanılmalıdır!
- RU** Крепежный комплект должен быть использован с багажной системой на крышу марки Cruz!
- IT** Questo kit di fissaggio deve essere usato con i portapacchi CRUZ
- NL** Deze bevestigingsset moet worden gebruikt in combinatie met Cruz dakdrager systeem!
- SLO** Kit za pričvrstitev naj se uporablja le z izdelki iz asortimana strešnih košar CRUZ!

